



DESERTTECH[®]
TOMORROWS WEAPONS

Welcome to the proud family of Desert Tech precision rifle owners. In acquiring your new HTI (Hard Target Interdiction) rifle, you are the owner of one of the most versatile precision rifle systems in the world. Whether you're a military marksman shooting a mile or a sportsman shooting 100 yards, the HTI offers unrivaled flexibility in an overall package. To get the most out of your HTI rifle, please read this manual from cover to cover before handling and operating the rifle for the first time.

READ THE OPERATING INSTRUCTIONS CAREFULLY

TABLE OF CONTENTS

FIREARM SAFETY	1
SPECIFICATIONS	3
FACTS ABOUT THE HTI	5
RIFLE SETUP	9
a) Conversion Kit Removal.....	9
b) Bolt/Barrel Tactile Indicator.....	11
c) Conversion Kit Installation.....	11
d) Forearm Rail Placement.....	13
e) Trigger Adjustment.....	14
f) Scope Mounting.....	16
g) Cheek-Piece Adjustment.....	19
h) Monopod Adjustment.....	20
RIFLE OPERATION	21
a) Magazine Loading and Unloading.....	21
b) Magazine Insertion and Removal.....	22
c) Firing the HTI.....	23
DISASSEMBLY AND REASSEMBLY	25
a) Bolt.....	25
b) Magazine.....	30

c) Stock Panels.....	32
CLEANING AND MAINTENANCE	33
a) Initial Cleaning.....	33
b) Periodic Maintenance.....	34
c) Lubrication Points.....	36
d) Storage.....	37
TROUBLESHOOTING	38
a) Failure to Fire.....	38
b) Failure to Feed from Magazine.....	41
c) Failure to Chamber.....	42
d) Failure to Eject or Extract.....	43
PARTS EXPLODED VIEW	45
a) Rifle.....	45
b) Chassis.....	46
c) Bolt.....	47
d) Magazine.....	48
e) Stock Panels.....	49
HTI ACCESSORIES	50
WARRANTY POLICY	56
LIMITATION OF LIABILITY	58
NOTES	59

WARNING!

KEEP OUT OF REACH OF CHILDREN!

IT IS DANGEROUS TO ALTER OR MODIFY THIS FIREARM IN ANY WAY. ANY ALTERATION OR MODIFICATION OF THE FIRING MECHANISM MAY RESULT IN THE FIREARM BECOMING UNSAFE. ANY ATTEMPT TO ALTER OR MODIFY THIS FIREARM WILL NULLIFY ALL WARRANTIES. THE USE OF REMANUFACTURED OR RELOADED AMMUNITION OF ANY KIND WILL ALSO VOID ALL WARRANTIES.

ALWAYS keep the firearm pointed in a safe direction.

ALWAYS keep your finger off the trigger until ready to shoot.

ALWAYS be sure of your target and what is beyond it.

ALWAYS keep the firearm unloaded until ready to use.

ALWAYS wear eye and ear protection.

Know how to use the firearm safely.

Be sure the firearm is safe to operate. Consult the owners manual before use of the firearm.

Use only the correct ammunition for your firearm.

Never use alcohol, over-the-counter prescription drugs, or other drugs before or while shooting.

Store firearms so they are not accessible to unauthorized persons.

For more information on firearm safety, visit the NRA Education and Training website: training.nra.org/nra-gun-safety-rules.aspx

WARNING!

Follow all local, state, and federal laws regarding legal use of your Desert Tech HTI rifle.

This item may be regulated for export by the U.S. Department of State or the U.S. Department of Commerce. Please see our export policy at www.deserttech.com for details.

FIREARM SAFETY

READ THE OPERATING INSTRUCTIONS CAREFULLY

Remember that even the safest firearm is potentially dangerous to you and others when it is not properly handled. Carefully read the operating instructions to learn how the rifle works and how it is to be handled.

WARNING: Carry out the following operations before any rifle configuration, cleaning, or disassembly: Move safety slide to “S” (safe) (page 22), remove the magazine, open the bolt, and visually ensure the chamber is clear (page 23).

Ensure the rifle is unloaded and safe whenever:

- Receiving or handing-off the rifle
- Transporting the rifle
- Cleaning or disassembly
- Scope mounting and rifle configuration
- You have stopped firing
- The rifle is not in use

Before firing the rifle:

- Always wear eye and ear protection
- Always be aware of the target and what lies beyond it

Make sure that the barrel is fully seated and barrel retention screws are tight before firing, as described on pages 11-13.

Do not use force when disassembling or assembling your rifle. A firearm can only be safe as long as it is in a flawless technical condition. Incorrect handling and/or lack of maintenance may lead to malfunctions and reduced safety of the firearm. Unauthorized modifications to the rifle or damages caused by the application of force will void the manufacturers warranty. Only a DT certified armorer is allowed to work on the rifle.

For more information on firearm safety, visit the NRA Education and Training website: training.nra.org/nra-gun-safety-rules.aspx

WARNING!

Follow all local, state, and federal laws regarding legal use of your Desert Tech HTI rifle.

REMEMBER:

TREAT ALL FIREARMS AS ALWAYS LOADED. LOOKING INTO THE END OF THE BARREL (MUZZLE) IS NOT RECOMMENDED AT ANY TIME.

SPECIFICATIONS

Weight (Rifle weight with conversion)

Rifle empty, no accessories	.375 CT	19.5 lb. (8.84 kg)
	.408 CT	20.35 lb. (9.23 kg)
	.416 Barrett	20.35 lb. (9.23 kg)
	.50 BMG	19.9 lb. (9.03 kg)

Length (Rifle length with conversion)

Minimum Length	.375 CT	45 inches (114.3 cm)
	.408 CT	45 inches (114.3 cm)
	.416 Barrett	45.75 inches (116.2 cm)
	.50 BMG	45.75 inches (116.2 cm)

Rate of Twist

.375 CT	1 in 10.25"
.408 CT	1 in 13"
.416 Barrett	1 in 13"
.50 BMG	1 in 15"

Mechanical Features

Method of operation:	Bolt Action
Method of feeding:	Magazine
Ejection:	Through port at right side

Sights

Picatinny rail (no taper)

Barrel

Type	Match fluted barrel
Length	29 in (73.66 cm)

Firing Characteristics

Maximum Effective Range	3000+ yards (.375 CheyTac)
-------------------------	----------------------------

Safeties

Fire Selector	Safe and Fire
---------------	---------------

Loctite Parts

Muzzle Brake
Feed Ramp Screw
Monopod Adapter
Trigger Mounting Screws
Bolt Sleeve Stop Set Screw
Coupler
Bolt Handle

Torque Specs

Rail Segment Screws	8 in/lb	0.9 nm
Stock Panel Screws	24 in/lb	2.71 nm
Trigger Position Screw	24 in/lb	2.71 nm
Trigger Mounting Screws	24 in/lb	2.71 nm
Sling Stud Screw	24 in/lb	2.71 nm
Cheek Piece Screw	24 in/lb	2.71 nm
Barrel Retention Screws	80 in/lb	9.04 nm

FACTS ABOUT THE HTI

The HTI rifle is a lightweight, bolt action operated, magazine-fed firearm. A brief description of the HTI rifle follows:

KEY FEATURES

Accuracy

The HTI achieves superb precision in all calibers because it's built around core accuracy components:

1. Match grade (free-floated) barrel, chamber and crowns.
2. High quality user-adjustable trigger.
3. Solid, repeatable return-to-zero barrel mounting system secures the barrel over the first eight inches of barrel assembly clamping surface.

Quick caliber conversion capability

The HTI rifle is available in .375 CheyTac, .408 CheyTac, .416 Barrett, and .50 Browning Machine Gun (.50 BMG/12.7x99mm NATO).

All cartridges have excellent accuracy at extreme distances and deep penetration on hard targets. A marksman now has the option to fire high-precision/low-recoil .375 CheyTac and switch to .50 BMG when the situation requires the delivery of Armor Piercing, Tracer, or Incendiary payload ammunition.

Compact

The HTI's bullpup design makes it one of the most compact and portable Hard Target rifles in the world. The HTI is 8.5 pounds lighter, 11 inches shorter, and more accurate than the U.S. M107A1 currently in service with the U.S. military.

Rugged

The HTI was designed to operate under harsh conditions and abuse. It utilizes high-impact polymers, aircraft grade aluminum, high-strength alloy steels, and durable coatings. The monolithic receiver serves as a full-length mounting chassis, eliminating the need for a bedding interface. Ergonomic stock panels attach directly to the receiver.

Ergonomics

The ergonomics and balance of the HTI are unmatched. We elected to build ergonomics into the rifle itself, instead of adding heavy accessories as an afterthought.

Ergonomic Feature List

Match grade trigger; adjustable for creep, travel, and weight (1-3 lb) .

The padded, adjustable cheek piece was designed into the rifle chassis for user comfort.

Comfortable rear support grip.

The raised recoil pad positions the shooters shoulder above the bore line, minimizing muzzle rise and felt recoil.

Ambidextrous safety slide is accessible without removing firing hand from pistol grip
60-degree bolt lift.

Rear magazine release lever easily facilitates one handed magazine changes

Weapon balancing point is approximately 1 inch forward of the trigger guard. Comfortable carrying grip is also located at balancing point.

Eight flush cup sling attachment points.

General Firearm Construction and Other Benefits

The barrel is attached to the receiver by four barrel retention screws and a barrel locking lug

The aluminum forearm is securely attached to the front of the receiver.

A full-length, MIL-STD-1913 rail runs along the top of the receiver and forearm, facilitating optics, night vision, thermals and other accessories. Rail segments attach to the sides for user-specified placement

The bolt assembly travels inside of the receiver; the bolt handle is located on the right side of the receiver (or left side, depending on right- or left-handed model)

Ambidextrous safety selector is located above the trigger guard, on the right and left side of the firearm

The recoil pad is attached to the rear end of the receiver.

Our magazines incorporate a "shoulder retention" feature that prevents the projectile tips from hitting the front of the magazine during recoil

The HTI is available in a variety of color configurations; all rifles are hard-coat anodized black and are additionally painted in black, flat dark earth, or olive drab. The stock panel color options are: black, flat dark earth, or olive drab

RIFLE SETUP

WARNING: Carry out the following operations before dismantling: Move safety slide to "S" (safe) (page 22), remove the magazine, open the bolt and visually ensure the chamber is clear (page 23).

a) Conversion Kit Removal

1. Depress the recoil pad lock switch (figure a-1).
2. While depressed, rotate the recoil pad approximately 45 degrees.

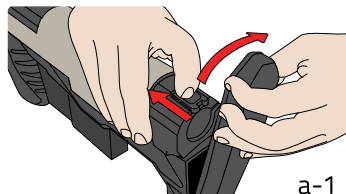

3. Lift bolt handle.
4. With the recoil pad rotated (figure a-1) slide the bolt rearward and out of the receiver (figure a-2).

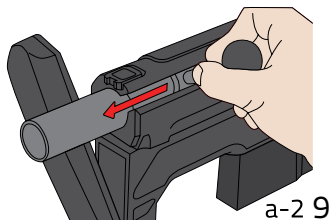

- Using a 5mm hex wrench loosen the four barrel retention screws (figure a-3).

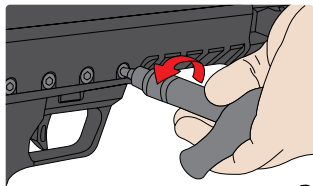

a-3

- Using a 5mm hex wrench rotate the barrel lock counter clockwise 180 degrees to unlock (figure a-4).
- Pull out barrel.

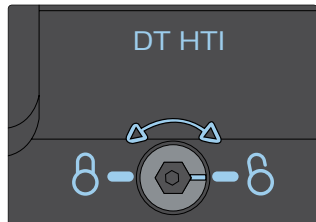

a-4

b) Bolt/Barrel Tactile Indicator

1. Ensure the caliber for the bolt matches the caliber of the barrel (figure b-1), signified by tactile indicators corresponding with the same number of tactile indicators on the bolt head.

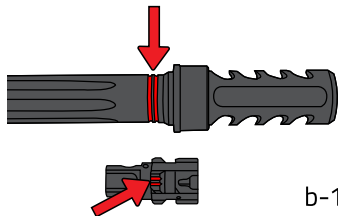

b-1

c) Conversion Kit Installation

1. Insert barrel into the receiver, note the locating notch on the barrel extension, position the notch in the six o'clock position (figure c-1).

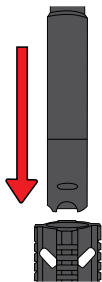

c-1

2. Make sure the barrel is fully seated against the feed ramp inside the HTI receiver (figure c-2).

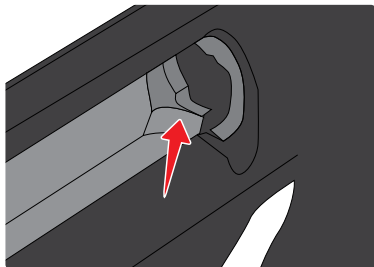

c-2

3. Insert the bolt assembly into the receiver (figure c-3). Fully close the bolt, by rotating the bolt handle downward 60 degrees to the lock position, this establishes head space. Engage the locking lug to the barrel extension by rotating the locking lug 180 degrees counter-clockwise to the "Lock" position, using a 5mm hex wrench. See page 10 for locking lug reference.

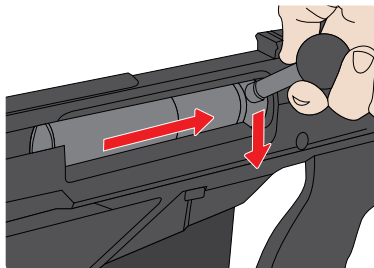

c-3

4. Using a 5mm hex wrench tighten the four barrel retention screws to 80 in/lb (9.04 nm) of torque from the front to the rear. A torque wrench is highly recommended for this step to prevent over tightening the barrel retention screws (figure c-4).

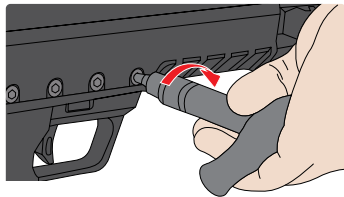

c-4

CAUTION: EXCEEDING THE TORQUE SPECIFICATION WHEN TIGHTENING THE BARREL RETENTION SCREWS CAN PERMANENTLY DAMAGE YOUR RECEIVER AND WILL VOID ALL WARRANTIES. Portable torque wrenches are available to purchase at our website at www.deserttech.com or by calling 801.975.7272.

d) Forearm Rail Placement

1. Place the forearm rails onto the forearm sides or bottom. Screw the rail onto the forearm with a 2.5mm hex-wrench to 8 in/lb (0.9 nm), (figure d-1).

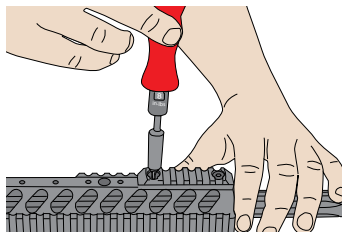

d-1 13

e) Trigger Adjustments

Trigger Creep Adjustment

1. Carry out the following operations before any adjustments: Move Safety Slide to "S" (Safe) (page 22), remove the magazine, open the bolt, and visually and physically ensure the chamber is clear (page 23).
2. Locate the Trigger Creep Screw through the small hole in the trigger guard located just in front of the trigger.
3. Using a 2.5mm hex-wrench, insert the end of the wrench through the hole in the trigger guard and into the Trigger Creep Screw (figure e-1).
4. Rotating the Trigger Creep Screw counter-clockwise will add additional creep to the trigger pull; rotating the screw clockwise will remove creep from the trigger pull.

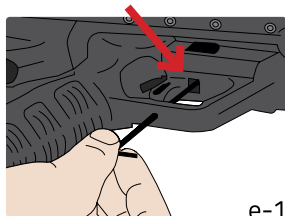

5. After adjusting your Trigger Creep Screw, ensure that the Safety Slide still has smooth, unrestricted movement to both the fire and safe positions (figure b-1, page 22). Use Blue Loctite 243 to secure it in position.
6. If movement is not free rotate your Trigger Creep Screw counter-clockwise until Safety Slide movement returns to a smooth, unrestricted feel.

Trigger Weight Adjustment

1. Insert a 2mm hex-wrench through the rear hole in the bottom of the trigger guard and into the rear screw on the trigger. Turn clockwise to increase trigger weight and counter clockwise to decrease weight (figure e-2).

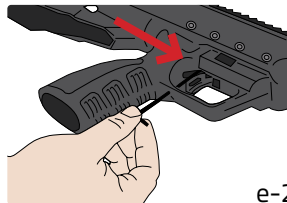

e-2

Trigger Position Adjustment

1. Using a 2.5mm hex wrench, loosen the screw on the side of the trigger. Slide trigger forward or back to the desired position, then tighten screw to 24 in/lb (2.71 nm).

f) Scope Mounting

1. Identify front of mount (figure f-1). Mount foot screws should be on the right side, with the front facing toward the muzzle.
2. Loosen, but do not remove, mount top screws. Next, loosen the mount foot screws.
3. Tilt mount on right side, placing scope feet under the picatinny rail (figure f-2).
4. Rotate mount until flat on top of picatinny rail (ensure left dove tail goes under rail).
5. Apply forward pressure on the mount to ensure positive engagement with the rail.

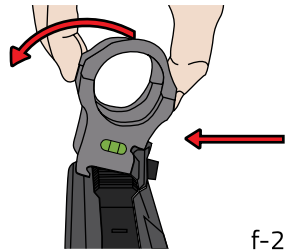
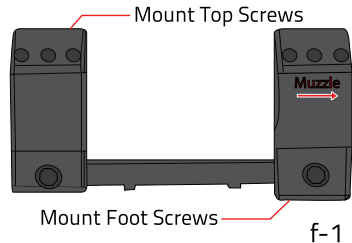

6. Tighten mount foot screws to 80 in/lb (9.04 nm).

7. Remove mount top screws.

8. Place scope in the bottom of the mount and install scope mount tops.

9. Finger tighten mount top screws. Leave them loose enough that the scope can still rotate/slide inside the mount (figure f-3).

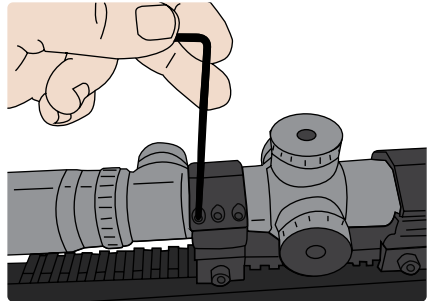

f-3

10. Establish eye relief

Get into your preferred shooting position

Pull rifle firmly into your shoulder

Close your eyes

Affirm cheek-weld

Open your eyes

Adjust scope forward or backward until any black ring goes away

11. Refer to your optics owners manual for scope leveling procedures.
12. Tighten top mount screws to 15 inch/lb (1.69 nm) using a 2.5mm hex-wrench by rotating from left to right in a crisscross pattern. (fig. f-4).

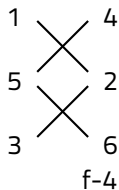

CAUTION: Do not use 3/32 hex-wrench to tighten screws, it will cause the screw head to strip.

g) Cheek-Piece Adjustment

1. With an 5mm hex wrench loosen the cheek-piece screw until the cheek-piece can move freely. The locking bolt is located on the opposite side of the cheek-piece (figure g-1).

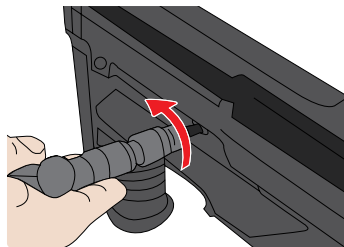

g-1

2. Set the cheek-piece to your desired height (figure g-2) and tighten the locking bolt on the opposite side to 24 in/lb, (2.71 nm). The cheek-piece was designed with locking teeth so there is no need to over-tighten the locking bolt.

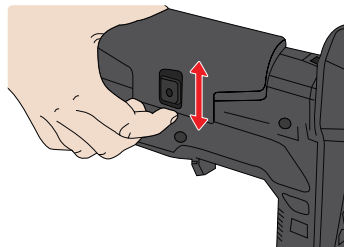

g-2

h) Monopod Adjustment

1. To quickly set the monopod to a desired height, shoulder the rifle in a prone position, then pull the monopod's knurled knob downward. The monopod's spring-loaded foot will drop down. Release the knurled knob to lock the monopod into position (figure h-1).
2. Twist the knurled knob clockwise and counter-clockwise for fine elevation adjustment (figure h-2).
3. To retract the monopod foot, pull the knurled knob downward while pushing the foot upward into the rifle.

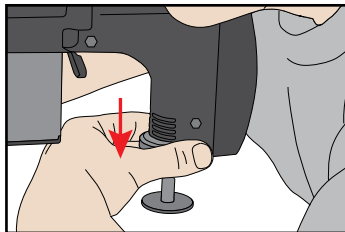

h-1

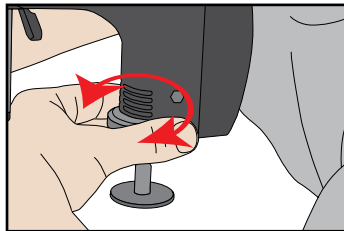

h-2

RIFLE OPERATION

a) Magazine Loading and Unloading

Loading Magazine

1. With the magazine in an upright position and slots facing you, place cartridge on the follower.
2. Press down and slide the cartridge rearward (figure a-1).
3. Repeat until loaded.
4. Do not load more than 5 cartridges in the magazine.

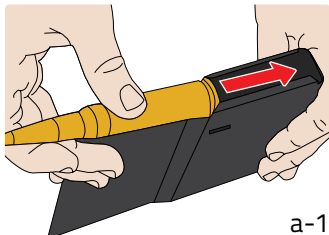

CAUTION: Ensure ammunition cartridge matches the cartridge of the bolt and the barrel.

Unloading Magazine

1. Push out cartridge with thumb (figure a-2).
2. Repeat until magazine is empty.

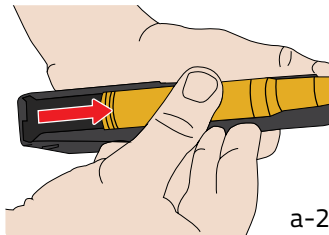

b) Magazine Insertion and Removal

Magazine Insertion

1. Clear the rifle by setting the fire selector on "S" (Safe) (figure b-1), removing the magazine, and clearing the chamber by opening the bolt to the rear.
2. Firmly insert the magazine to fully lock the magazine into position (figure b-2). Above the magazine well there is an indicator window that, if fully covered with a metal tab, indicates that the magazine is properly inserted.

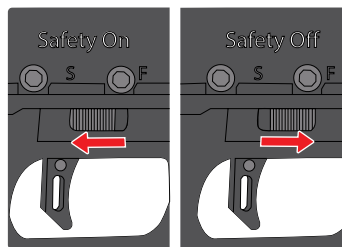

b-1

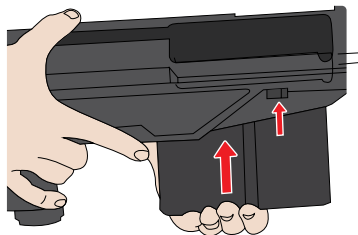

b-2

Magazine Removal

1. To remove the magazine, press the magazine release button forward and pull downward on the magazine (figure b-3).

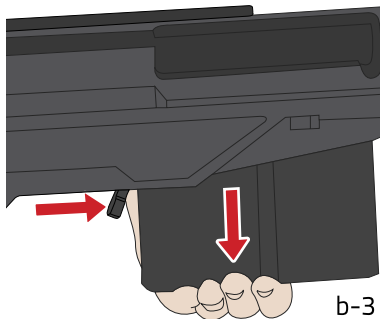

c) Firing The HTI

WARNING: Never chamber a round until you are ready to fire.

WARNING: Wear eye and ear protection while operating the rifle.

WARNING: See page 33 for initial cleaning before operating rifle.

1. Insert a loaded magazine with the bolt to the rear.
2. Run bolt forward and lock downward into place.
3. Set safety slide to "F" (Fire) (figure c-1).
4. With a round chambered, the rifle is now ready to fire.
5. Press the trigger to fire.

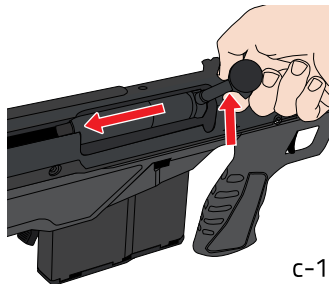

DISASSEMBLY AND REASSEMBLY

a) Bolt

Bolt Disassembly

1. Hold the bolt with the end cap facing away and with your left thumb, push on the striker tab toward the bolt handle (figure a-1).
2. With the bolt now in the fired position, grip the bolt handle and bolt sleeve; rotate the bolt sleeve clockwise to remove the end cap. The end cap is under pressure due to the firing pin spring, and will shoot out, if over-rotated. To avoid this, firmly place your left index finger over the end cap while removing it (figure a-2).

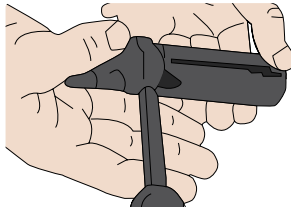

a-1

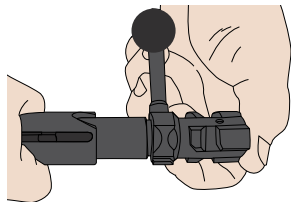

a-2

WARNING: The striker spring is under pressure! Wear safety glasses and take caution when removing the end cap!

3. After removing the striker spring and end cap, remove the bolt sleeve and striker (figure a-3).

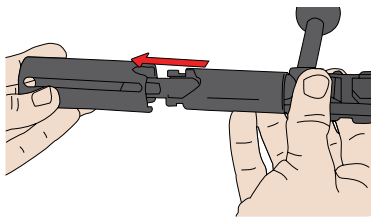

a-3

4. Remove firing pin (figure a-4).

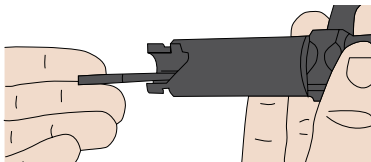

a-4

5. Remove bolt body pin and bolt head (figure a-5).

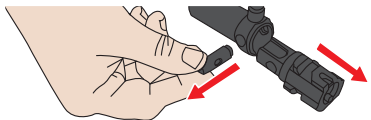

a-5

Bolt Reassembly

Note: For parts exploded view, see page 47.

1. Place bolt head into the bolt body. Align extractor of the bolt head with the bolt handle (figure a-6). Press or tap the bolt body pin with a small brass hammer until it is fully seated into the bolt body

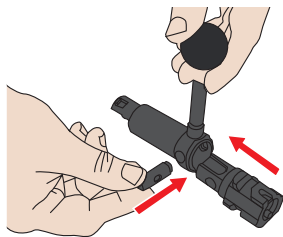

a-6

2. Drop the firing pin into the bolt body, making sure it protrudes out the firing pin hole (figure a-7)

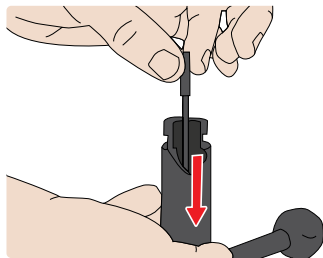

a-7

3. Insert the striker inside the bolt sleeve slot with the striker tab protruding out, then slide the striker and bolt sleeve onto the bolt (figure a-8).

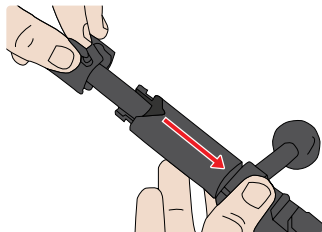

a-8

4. Make sure the striker is seated to the far counter clockwise position (figure a-9).

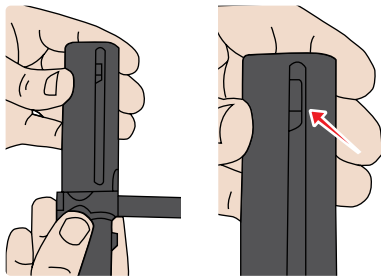

a-9

5. Insert the striker spring into the striker and place the end cap on top of the spring and striker, making sure the slot in the end cap slides over the striker tab (figure a-10).

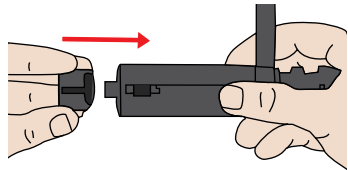

a-10

6. Place the bolt face down on a hard surface. Depress the end cap with 3/8" drive tool until just a little below the bolt sleeve. Once flush, rotate the sleeve clockwise approximately 1/4" until the striker snaps forward into position (figure a-11).

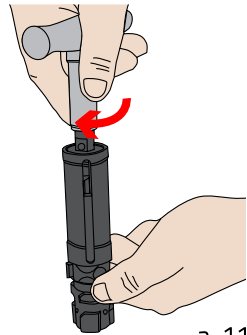

a-11

WARNING: The firing pin spring is under pressure! Wear safety glasses and take caution when installing the end cap!

b) Magazine

WARNING: Remove all cartridges before disassembling the magazine.

Magazine Disassembly

1. Before disassembling the magazine, remove all cartridges.
2. Hold magazine with bottom facing upwards.

WARNING: The magazine spring is under pressure! Wear safety glasses and take caution when removing the floor plate!

3. With the aid of a small pointed object, push spring guide inward (figure b-1).
4. With spring guide depressed, carefully pull the magazine floor plate rearward approximately an inch.
5. Remove magazine floor plate.

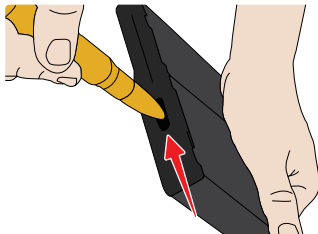

b-1

- Ease the spring and follower out of housing (figure b-2).

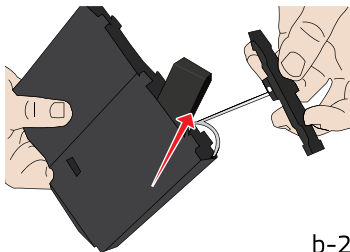

b-2

Magazine Reassembly

- Insert follower with cavity at a 90 degree angle through the magazine bottom (figure b-3). Rotate the follower into position. Ensure the spring loop is to the back of the magazine, ensuring the bend of the spring points to the front. (see page 48)
- From this point on, assembly is reverse of disassembly.

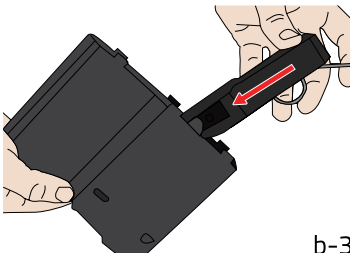

b-3

c) Stock Panels

Stock Panel Removal

1. Place the HTI rifle upside down on a clean, flat surface. With 4mm and 5mm hex wrenches, remove the screws in front of the trigger guard and inside the pistol grip (figure c-1). Lift off the front section of the stock panel.
2. Completely unscrew the HTI monopod. With a 5mm hex wrench, unscrew the hex screw found in the access hole forward of the monopod (figure c-2).
3. Release and rotate the recoil pad (page 9, figure a-2) then lift the rear stock panel up.

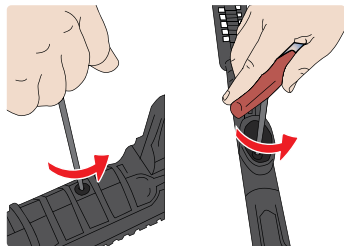

c-1

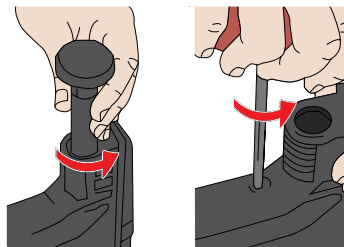

c-2

Stock Panel Installation

Stock panel installation is reverse of removal. Tighten screws to 24 in/lb (2.71nm).

CLEANING AND MAINTENANCE

GENERAL

Comprehensive knowledge of how to service and handle firearms is of great importance. Experience has shown that most failures, which occur while operating a firearm, are due to negligence in maintenance. Special attention must be paid to cleaning, lubricating, and inspecting the rifle; this will determine whether or not the rifle will function properly. In order to maintain accuracy, the barrel must be maintained properly. The receiver, bolt assembly, and other moving parts of the rifle must be kept clean and lightly lubricated to ensure proper operation of the rifle.

a) Initial Cleaning

WARNING: Never use abrasive or metallic materials to clean your HTI.

Note: When the rifle is purchased or after it has been stored for long periods of time the rifle should be cleaned before use.

1. Adhere to all rifle safety precautions.
2. Clear the rifle. Move safety slide to "S" (safe) (page 22), remove the magazine, open the bolt, and visually ensure the chamber is clear (page 23).

3. Any heavy or gummy deposits may be removed using very light rust-preventative oils. After cleaning, wipe dry and lightly coat with gun oil as directed (see page 36 for lubrication points).

b) Periodic Maintenance

Barrel

Desert Tech recommends cleaning the barrel when accuracy begins to deteriorate, and using bore cleaning foam and the properly sized bore snake. Follow cleaner product instructions when cleaning the barrel.

Muzzle Brake:

Ensure the ports are clear of debris and occasionally check to ensure the brake is securely fastened.

Magazine:

The magazine should be disassembled (pages 30-31), cleaned, and lightly oiled regularly.

Receiver Interior:

A visual and manual inspection of the inside of the receiver will reveal what, if any, cleaning is necessary. Most debris can be removed with a cloth or cleaning patch.

Bolt Face:

Ensure the bolt face is free from debris. This area can be wiped clean. This is also a good time to ensure that the ejectors and extractor are functioning properly by manually actuating them to ensure proper spring function and return. Also, a light amount of lubricant may be applied to the bolt face at this time.

Bolt Interior:

The operator should occasionally remove the firing pin assembly from the bolt (see pages 25-29). Wipe this area clean and apply a light amount of lubricant.

c) Lubrication points

1. Desert Tech recommends a moly-based grease for bolt head lubrication. Using a cotton swab, apply a small amount of moly grease to the rear of the **six** bolt head lugs (red areas).
2. Apply a light coat of gun oil around the raised surface of the bolt sleeve, bolt body and striker points (green areas).

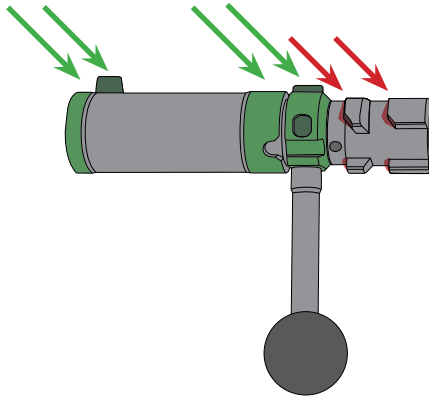

d) Storage

WARNING!

KEEP OUT OF REACH OF CHILDREN!

1. Ensure the rifle chamber is clear and the magazine is unloaded and the rifle is on "S" (safe) position.
2. If possible, store rifle in a gun safe, with the butt of the stock resting on the ground and the muzzle pointed up.
3. If a safe is unavailable, store in a secure location, ensuring it is out of reach of children.

TROUBLESHOOTING

a) **Failure to Fire** * Striker assembly snaps home but rifle will not fire.

Warning: If the rifle fails to fire with a live round in the chamber of a hot barrel, (a misfire or jam) keep the rifle pointed in a safe direction, place the safety slide on the "S" (safe) position, and wait 30+ seconds before trying to remove the round. If you cannot remove the round, remove the magazine and wait at least 15 minutes with the rifle pointed in safe direction, then proceed from the following troubleshooting procedures to safely determine the cause of the malfunction and return the rifle to a safe condition.

Cause	Remedy
1. Magazine is empty	Open the bolt to remove possible last round. Inspect chamber and, if empty, insert full magazine and close the bolt to continue firing.

Cause	Remedy
<p>2. Magazine is not empty (Malfunction)</p>	<p>Cycle the bolt and clear possible defective or incorrectly positioned round. If a round or case ejects, inspect chamber. If empty, reload and continue firing. If nothing ejects, fully draw back bolt and check if cartridge or case is chambered. If empty, reload and continue firing. If base of cartridge is visible, close bolt and fire in a safe direction. If rifle fires and ejects, reload and continue. If rifle does not fire, set the safety slide to "S" (safe) and follow Failure to Extract on page 43.</p>

Cause	Remedy
3. Bolt not fully closed	Follow procedure for incorrect bolt manipulation(see page 42).
4. Defective Cartridge	Inspect primer. If fully indented, wait for 15 minutes then discard safely. If not fully indented, check firing mechanism.
5. Dirty firing mechanism, defective firing pin, or defective striker assembly.	Check for sluggishness of operation. Clean and replace as necessary.
6. Barrel not properly seated.	Make sure the locating notch on the barrel extension lines up with the feed ramp inside of the receiver and barrel locking lug is in its locked position (see page 11-13).

b) Failure to Feed from Magazine * Rifle jams with empty chamber

Cause	Remedy
1. Incorrect bolt manipulation	Clear jam if necessary and cycle the bolt.
2. Malfunctioning magazine	Replace with Desert Tech factory magazine.
3. Magazine improperly seated	Remove magazine and reinstall until magazine catch engages.
4. Magazine improperly loaded	Seat top cartridge properly. Check that the amount of cartridges in the magazine is compliant with magazine cartridge capacity.
5. Dirty magazine	Disassemble magazine and clean, (see pages 30-31, 34).
6. Damaged magazine	Replace with DT factory magazine.
7. Double feeding of cartridge	Inspect for stuck case or cartridge and check extractor and ejector.

c) Failure to Chamber

* Bolt does not fully close and rifle will not fire

Cause	Remedy
<ol style="list-style-type: none"><li data-bbox="136 249 560 280">1. Incorrect bolt manipulation<li data-bbox="136 377 376 408">2. Dirty chamber<li data-bbox="136 430 488 462">3. Defective ammunition<li data-bbox="136 484 472 515">4. Excessively dirty rifle	<p data-bbox="725 249 1146 358">Remove magazine, cycle bolt, replace magazine, and cycle bolt to chamber round.</p> <p data-bbox="725 377 948 408">Clean Chamber.</p> <p data-bbox="725 430 1159 462">Check for damaged cartridges.</p> <p data-bbox="725 484 1172 635">Check for sluggishness in bolt and firing mechanism. Clean and oil as necessary (see pages 31-36 for general cleaning).</p>

d) Failure to Extract or Eject * The fired case may not eject, or the rifle may jam (spent case left in chamber)

Caution: The following procedure should be carried out only after following the WARNING on page 38.

Cause	Remedy
<p>1. Overpowered or defective ammunition (stuck case)</p>	<p>Remove bolt. With barrel in place, insert cleaning rod through the front of the barrel. Push or tap gently to remove obstruction.</p> <p>Check chamber and bore. Clean before reassembly.</p> <p>If obstruction cannot be removed, disassemble barrel and contact authorized service station.</p>

Cause	Remedy
1. Overpowered or defective ammunition (continued)	Check ammunition and change to a different brand of current commercially manufactured ammunition.
2. Dirty or damaged chamber	Inspect, clean, replace barrel if necessary.
3. Fouled extractor	Clean extractor. (See page 35).
4. Extractor defective or missing	Replace extractor.
5. Damaged ejector	Replace ejector.

PARTS EXPLODED VIEW

HTI Main Rifle Assembly



Chassis Receiver Assembly

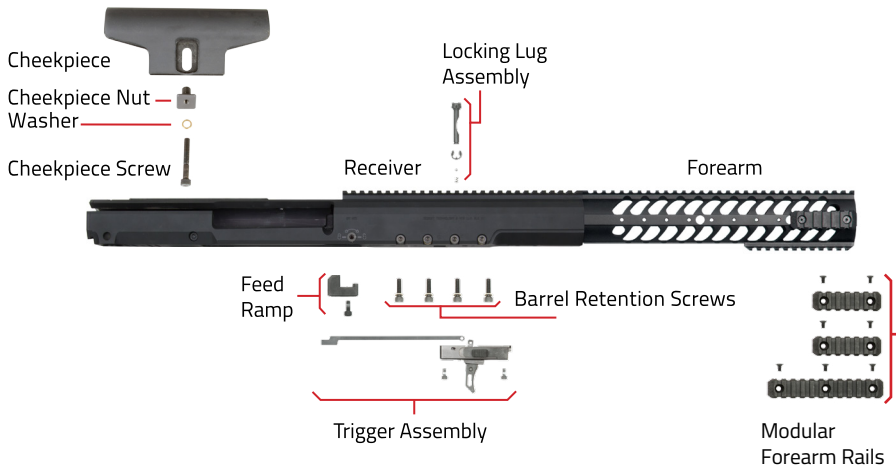

Bolt

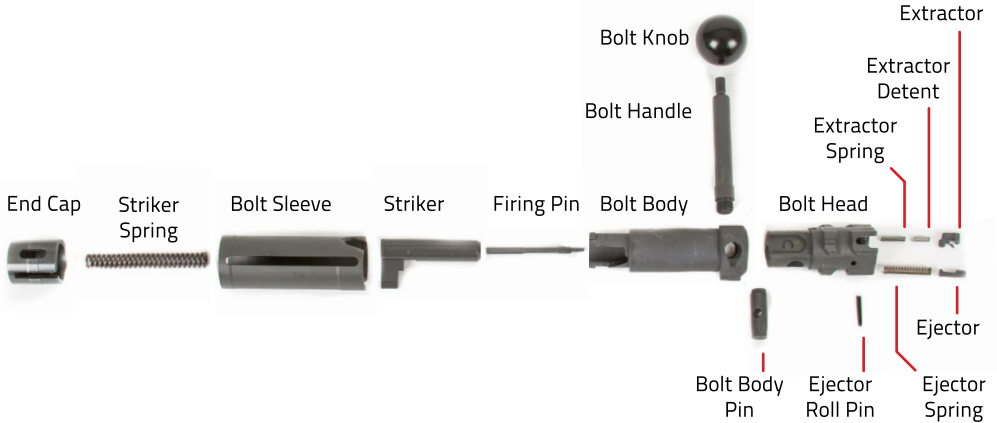

Magazine

Floor Plate



Spring Guide



Spring



Follower



Magazine Housing



Stock Panels and Buttpad Group

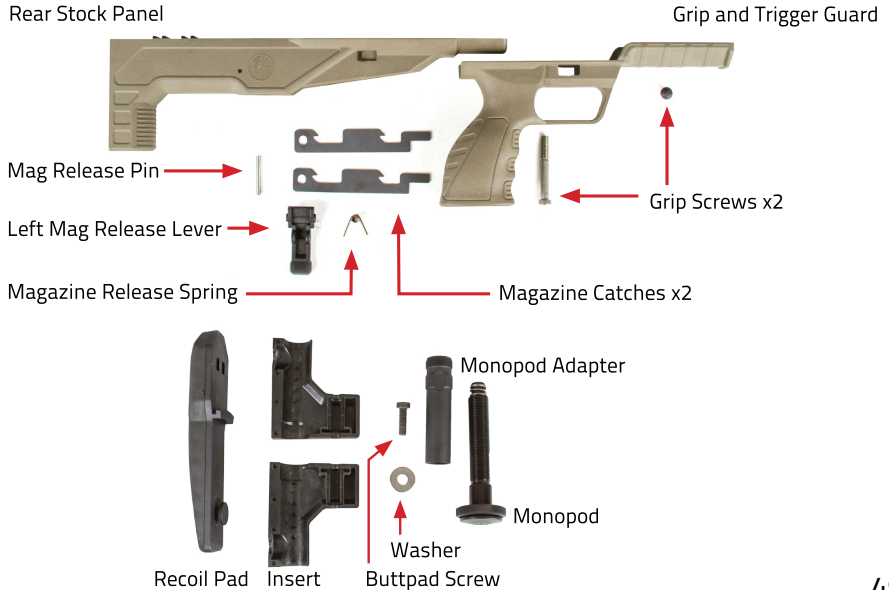

HTI ACCESSORIES

More available at www.deserttech.com



DT Elite Iron Suppressor .375 and .50

This suppressor is built to take the extreme pressures of these ultra high velocity rounds. This sound suppressor has excellent sound reduction and greatly tames recoil.

Elite Iron and LRA Bipods

These bipods provide a lightweight, high-strength, and stable shooting support bipod option for the HTI or SRS-A1.



Elite Iron



LRA



DT HTI Operators Maintenance Kit

A complete operator maintenance solution in a portable package. It combines our operator's tool kit and cleaning kit in a nylon MOLLE gear bag, and contains all the tools and cleaning components you'll need in the field or on the bench.

HTI CONVERSION KITS

.50 BMG/12.7x99mm NATO

.416 Barrett

.408 CheyTac

.375 CheyTac



.50 BMG

.416 Barrett

.408 CheyTac

.375 CheyTac



DESERTTECH[®]
MUNITIONS

**A RIFLE IS ONLY AS
ACCURATE AS THE
AMMUNITION IT FIRES**



Desert Tech Munitions

exists because we weren't satisfied with the performance from existing ammunition manufacturers, due to inconsistency problems and wild variations when switching between lots. We realized that, by controlling all components in the firing cycle, the rifle and ammunition combination could be harmonized to create a package that performs at the highest end of the precision spectrum.



For any shooter who demands the absolute best performance and accuracy, Desert Tech Munitions provides factory ammunition that optimizes the Desert Tech rifle system to the fullest.

Available and upcoming cartridges from DTM:

- .223 Rem
- .338 Lapua Mag
- 6.5 Creedmoor
- .375 Chey Tac
- .308 Win
- .50 BMG
- .300 Win Mag





DESERTTECH[®]
TRAINING



ONE OF THE LARGEST PREMIER TRAINING FACILITY IN THE WEST

The Desert Tech Training Facility

is one of the largest premier training facility in the west, located on 25,000 acres in northeastern Utah. The Desert Tech Training Facility was created to provide a place for shooters and operators from around the world to obtain unparalleled firearms instruction.

The Desert Tech Training team of instructors offer extensive real-world military experience and a specialized Law Enforcement knowledge base to provide the most practical training opportunities. The curriculum has been designed to provide military, LE, contractors, and armed citizens real-life scenarios that induce stress, which will produce a better gunfighter, not just a better shooter.



Every course is focused on developing the skill sets required for peak performance under the stress of real-world situations.

The Desert Tech Training Facility provides first class accommodations to complement their extensive selection of ranges. The DT Training Facility provides opportunities to train in everything from breaching & demolition to high angle counter sniper. For any and every scenario, the DT Training Facility will have the location and an experienced instructor to provide the best training possible.

Available Courses

Pistol/Carbine
Concealed Carry
Long Range Precision Rifle
Designated Marksman
High Angle Marksmanship
Car Course

Corporate Team Building
Low Light Marksmanship
Tactical Breacher
Sniper Field Craft
Sniper Team Course



Ranges and Bays

TRAINING BAYS, PHASE 1 (see map)

1. 100 yard zero
2. Square Bay: 50'x50' w/movers
3. Car Bay: 4 cars w/customizable positions
4. Obstacle Bay: 8 barricades & platforms
5. Steel Bay: Multiple target styles
6. Breaching & Demolition
7. Multipurpose Machine Gun range
8. Sniper Range: Known distance
9. Sniper Range: Unknown distance

PHASE 2

10. Indoor Range
11. Kill House
12. Convoy Live-Fire Course
13. 270-degree Car Course
14. Forward Operating Base (FOB)
15. MOUT Town (Military Operations on Urban Terrain)
16. Rough Terrain Driving Course
17. Classroom

OPEN COUNTRY RANGES

- High Angle: 400 - 1500 yds
- Known Distance: 100 - 1800 yds
- Unknown Distance: 300 - 1200 yds

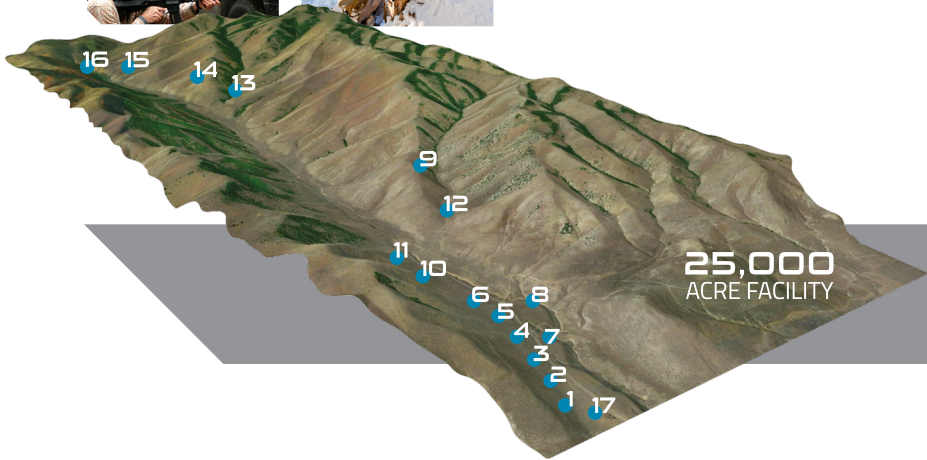

DESERT TECH WARRANTY POLICY

- Desert Tech warrants to the initial retail purchaser that for three (3) years from the date of purchase, your Desert Tech SRS A-1, SRS A-1 Covert, HTI, MDR, and R7S, including the chassis, conversion kits, scope mounts, muzzle brakes and magazines will be free from manufacturing defects in workmanship and/or material.
- Desert Tech warrants to the initial retail purchaser that your Desert Tech Sound Suppressor will be free from defects in workmanship and/or material for a LIMITED LIFETIME.
- This warranty is null and void if the firearm has been misused, damaged (by accident or otherwise), fired with hand loaded, reloaded or improper ammunition, fired with an obstruction in the barrel, damaged through failure to provide reasonable and necessary maintenance as described in the manual accompanying the firearm, or if unauthorized repair or any alteration, including of a cosmetic nature, has been performed on the firearm. This limited warranty does not apply to normal wear and tear of any parts.
- Desert Tech is not responsible for any required BATFE taxes or fees.
- Warranty does not cover third-party products. Third-party product warranties must be pursued directly through the product manufacturer.
- Product registration must be completed online by the original owner within 30 days of the purchase date in order to make a claim under this warranty. In the event of an incomplete registration, the owner must provide proof of purchase in the form of a Dealer Invoice.
- Any NFA item (I.E. Suppressor, Short-Barreled Rifle or Machine Gun) to be returned must be accompanied by a copy of its corresponding Form 3, 4, 5, or 9. The Form must be packaged inside the box with the NFA item. If the proper form is not included, the product will be returned to sender.
- If a valid claim is made within the warranty period and is shipped to the Desert Tech service center, the product will be repaired or replaced (at our discretion) free of charge.

-Products sent back for testing that require range time but are found to be working as intended will have a \$50.00 + ammo fee applied. These charges must be taken care of prior to return shipping to the customer.

-To make a claim, you must first obtain a Return Merchandise Authorization number by either completing the online warranty form located at WWW.DESERTTECH.COM, calling (801) 975-7272 ext. 132, or by emailing WARRANTYSERVICE@DESERTTECH.COM. Claims must be made directly through Desert Tech, not your local dealer.

-The cost of shipping to Desert Tech is the responsibility of the customer. Desert Tech will cover the cost of ground shipping back to the customer if it is a valid warranty claim. Customer is responsible for any expedited shipping charges.

-In no event shall Desert Tech be liable for any incidental or consequential damages arising from or in connection with this warranty.

-WARRANTY IS VALID IN THE UNITED STATES AND CANADA ONLY

-This warranty gives you specific legal rights, and you may have other rights which vary from state to state. For international customers, contact your local service center.

-Shipping information:

Attn: Warranty Dept. RMA# _____

1995 W Alexander St

West Valley City, UT 84119

LIMITATION OF LIABILITY

The liability of Desert Tech LLC. for any and all losses and/or damage to the purchase shall in no event exceed the purchase price of the Rifle. In no event shall Desert Tech LLC. be liable for incidental or consequential damage. User assumes all risks and liabilities arising from the use of this product.

No part of this document may be copied, reproduced, or transmitted by any means, for any purpose without permission from Desert Tech LLC.

All images and text©2008-2016 DT LLC

Hard Target Interdiction US PATENT D584373, 9194641

Notes:

Notes:

Notes:

Notes:



DESERTTECH[®]
TOMORROWS WEAPONS